

# Sun FLeX Series Solenoid Valves

## HIGH RELIABILITY

10 million on-off operational cycles

## LOW INTERNAL LEAKAGE

Less than one drop per minute

## USE WITH ANY OF THREE COILS

Energy-saving (3000-psi), high-power (5000 psi), & hazardous locations



# DFB\*

5000/3000 psi (350/210 bar)

## 2-WAY, 2-STAGE SOLENOID-OPERATED DIRECTIONAL POPPET VALVES

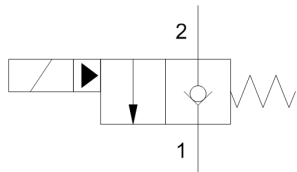

DFBD-\*C\*  
3000 psi (210 bar)

DFBF-\*C\*  
5000 psi (350 bar)

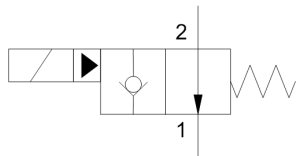

DFBD-\*H\*  
3000 psi (210 bar)

DFBF-\*H\*  
5000 psi (350 bar)

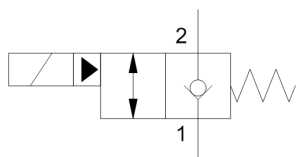

DFBE-\*C\*  
3000 psi (210 bar)

DFBG-\*C\*  
5000 psi (350 bar)

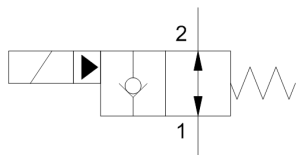

DFBE-\*H\*  
3000 psi (210 bar)

DFBG-\*H\*  
5000 psi (350 bar)

## TABLE OF CONTENTS

Valve Functionality	2
Technical Features	2
Model Configurations & Options	3
Technical Specifications	4
Performance Curves	5
Dimensional Drawings	6
Cavity Drawings/Tooling	7
Additional Information	8

[sunhydraulics.com/model/DFB\\*](http://sunhydraulics.com/model/DFB*)

## DFB\* 2-WAY, 2-STAGE, SOLENOID-OPERATED DIRECTIONAL POPPET VALVE, FLOW 2-1

## SERIES 0, CAVITY: T-162A

The 2/2 directional poppet valves are pilot operated. They comprise a hex body (3), solenoid with coil (2), poppet (5), dart (4), coil nut (1), ball (6), pin (7), and a spring (8).

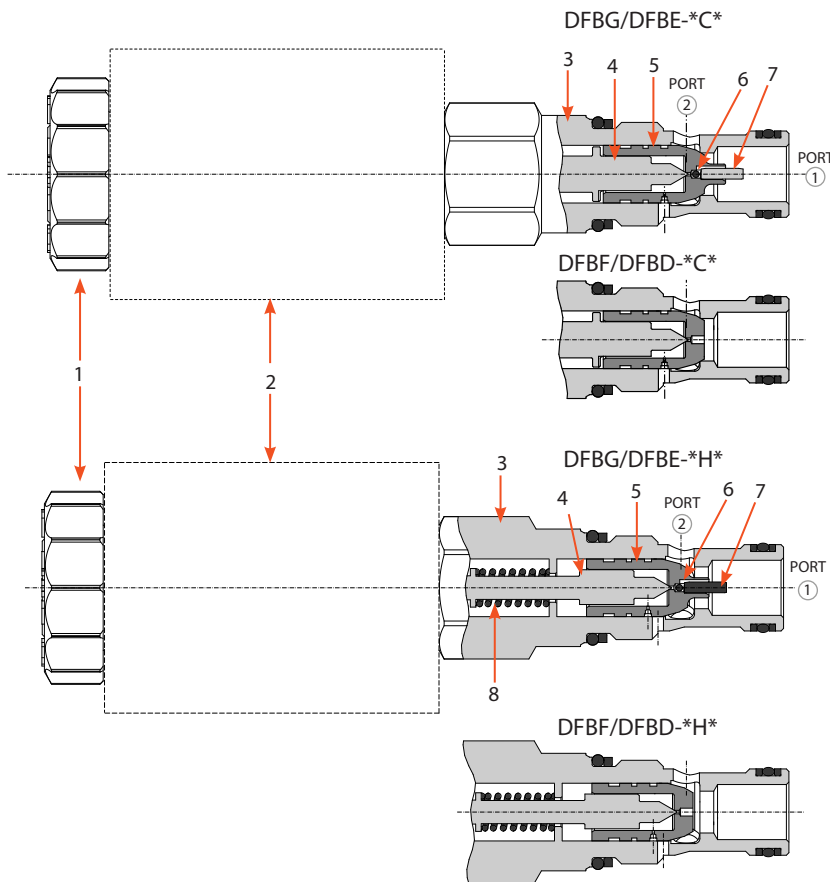

### DFB-\*C\* (normally closed)

**Function:** When de-energized, the dart (4) rests on the poppet (5), which in turn rests on the sleeve seat (3). In this condition, flow is blocked from 2 to 1 but will free flow 1 to 2. When energized, the dart lifts from the poppet, the poppet follows the dart and lifts away from the seat, creating an open path from 2 to 1.

If the DFBF or DFBD is open and flow is routed 1 to 2, the valve will auto close and only pilot flow will pass from 1 to 2. For the DFBG & DFBE, the check valve (6 & 7) at the nose of the poppet will allow free flow from 1 to 2 whether the valve is open or closed.

### DFB-\*H\* (normally open)

**Function:** When de-energized, the dart (4) and poppet (5) are lifted away from the sleeve seat by the spring (8), allowing an open flow path from 2 to 1. When energized, the dart pushes into the poppet seat, and the poppet pushes into the sleeve seat, closing the valve. Flow is blocked 2 to 1 but can free flow 1 to 2.

If the DFBF or DFBD is open and flow is routed 1 to 2, the valve will auto close and only pilot flow will pass from 1 to 2. For the DFBG & DFBE, the check valve (6 & 7) at the nose of the poppet will allow free flow 1 to 2 whether the valve is open or closed.

## TECHNICAL FEATURES

- All FLeX Series valves incorporate the Sun floating-style construction to minimize the possibility of internal parts binding due to excessive installation torque and/or cavity/cartridge machining variations.
- Designed and tested to 10 million on-off operational cycles.
- Meets new NFPA test standard T2.6.1 R2014 for fatigue and burst pressure ratings.
- Higher flow rates than competing valves of similar size.
- Designed using CFD fluid simulation for optimized geometries.
- Valves have extremely low leakage rate – less than 1 drop/min or 0.004 in<sup>3</sup> (0.07 cc<sup>3</sup>)/min
- Zinc-nickel plating standard for 1000-hour salt fog protection.
- Available with a manual push-version override option on normally open versions.
- A wide variety of coil termination and voltage options are available, with and without surge protection. See the CONFIGURATION section.
- The 5000-psi (350-bar) valves in the DFB\* family use the high-power (25-W) FLeX coils; the 3000-psi (210-bar) DFB\* valves use the low-power (17-W) coils. Note that all DFB\* valves can be used with the hazardous location coils. See table on P 3.
- Coil connector options offer ratings up to IP69K. See individual coil product pages for details.

## MODEL CODE EXPLANATION

Sun cartridges have a base seven-digit part number. Each of the digits in the sequence has significance as shown in the model code explanation below. Available options and

modifiers for specific cartridges, manifolds, and valve packages are shown on the individual product pages and data sheets. All modifiers are not applicable for every model.

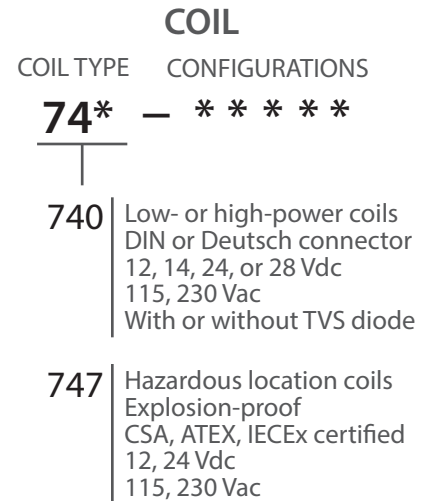
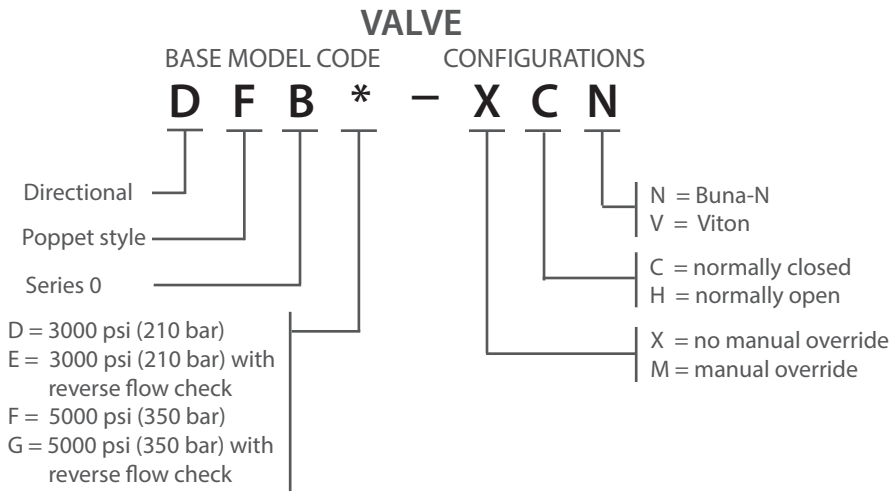

### Important Note:

When performing model code searches on [www.sunhydraulics.com](http://www.sunhydraulics.com), do not include setting(s). When ordering, no spaces or dashes are used.

See individual coil data sheets for full coil configuration.

## COMPATIBLE FLeX SERIES COILS

The DFBD and DFBE 3000-psi (210-bar) valves use the low-power (17-W) FLeX coils; the DFBF and DFBG 5000-psi (350-bar) valves use the high-power (25-W) FLeX coils. Note that all DFB\* valves can be used with the hazardous location coils.

### Low-Power (17-W) & High-Power (25-W) Coils

Voltage	DIN 43650 Form A (IP65/IP67)		Deutsch DT04-2P (IP69K)		Resistance @20°C (ohms) ±10% (with diode*)	TVS Diode (Nominal) Breakdown Voltage (with diode*)
	High-Power	Low-Power	High-Power	Low-Power		
12 Vdc	740-212	740-212L	740-912	740-912L	5.8 ohms	68 Vdc
14 Vdc	740-214	740-214L	740-914	740-914L	7.8 ohms	68 Vdc
24 Vdc	740-224	740-224L	740-924	740-924L	23.0 ohms	68 Vdc
28 Vdc	740-228	740-228L	740-928	740-928L	31.4 ohms	68 Vdc
115 Vac	740-211	740-211L	N/A	N/A	416 ohms	250 Vac
230 Vac	740-223	740-223L	N/A	N/A	1686 ohms	400 Vac

\* Above model codes are shown without transient voltage suppression (TVS) diodes. To order FLeX coils with a TVS diode, append model code with "D" (Example: 740-212LD).

### Hazardous Location, Explosion-Proof (30-W) Coils

Voltage	M20 x 1.5 180°	M20 x 1.5 90°	1/2" NPT 180°	1/2" NPT 90°	Wattage @ 20°C	Circuitry
12 Vdc	747-JM12BD	747-JM12CD	747-JN12BD	747-JN12CD	29.6 W	With diode
24 Vdc	747-JM24BD	747-JM24CD	747-JN24BD	747-JN24CD	29.9 W	With diode
115 Vac	747-JM11BD	747-JM11CD	747-JN11BD	747-JN11CD	29.7 W	Rectified
230 Vac	747-JM23BD	747-JM23CD	747-JN23BD	747-JN23CD	28.9 W	Rectified

**DFB\*** 2-WAY, 2-STAGE, SOLENOID-OPERATED  
DIRECTIONAL POPPET VALVE, FLOW 2-1

SERIES 0, CAVITY: T-162A

TECHNICAL SPECIFICATIONS	DFBD	DFBF	DFBE	DFBG
Maximum Operating Pressure	3000 psi (210 bar)	5000 psi (350 bar)	3000 psi (210 bar)	5000 psi (350 bar)
Flow Rate/Capacity - Nominal	10 gpm (40 L/min)*			
Sun Cavity	T-162A			
Sun Cartridge Series	Series 0			
Check Cracking Pressure - Typical	50 psi (3.45 bar)			
Response Time - Typical	50 ms (open & close)			
Maximum Internal Leakage at 110 SUS (24 cSt) at Maximum Operating Pressure	0.004 in <sup>3</sup> (0.07 cc <sup>3</sup> )/min (1 drop/min)			
Switching Frequency - Maximum	15,000 cycles/hour			
Manual Override Option	Available on normally open versions only			
Viscosity Range	2,8 to 380 cSt or 35 to 2000 SUS			
Filtration	Minimum cleanliness (ISO 4406 1999, 4/6/14 µm) 19/17/14			
Valve Hex Size	0.75 in (19,1 mm)			
Valve Installation Torque	20 - 25 lbf ft (27 - 34 N-m)			
Mounting Position	No restrictions			
Valve Weight (excluding coil)	5.6 oz (159 g)			
Seal Kit - Viton	990-162-006			
Seal Kit - Buna N	990-162-007			

\* See performance curves on P 5 for more details.

## TYPICAL PRESSURE DIFFERENTIAL VS. FLOW

**DFBD-\*C\* & DFBF-\*C\***  
(Normally closed)

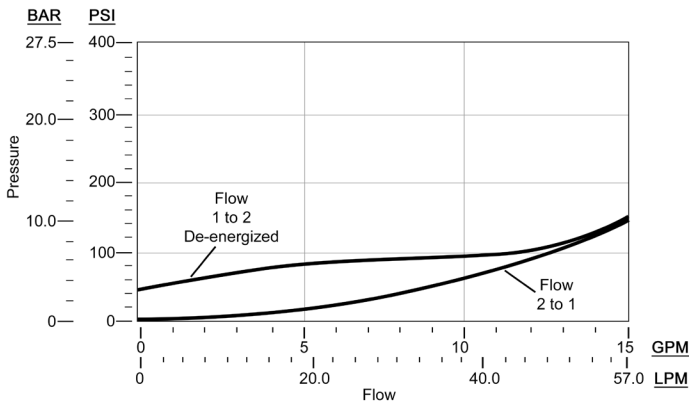

**DFBE-\*C\* & DFBG-\*C\***  
(Normally closed)

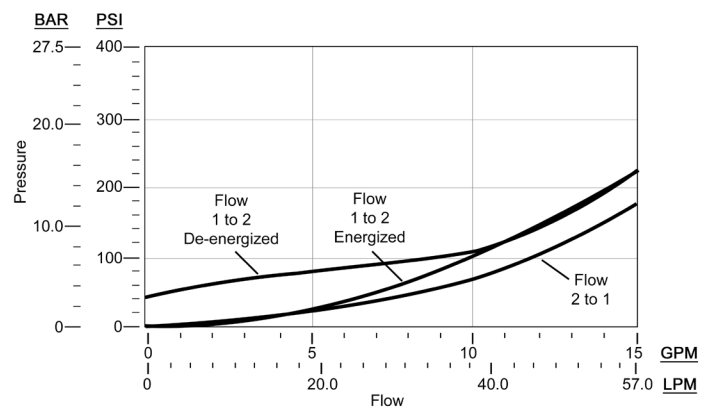

**DFBD-\*H\* & DFBF-\*H\***  
(Normally open)

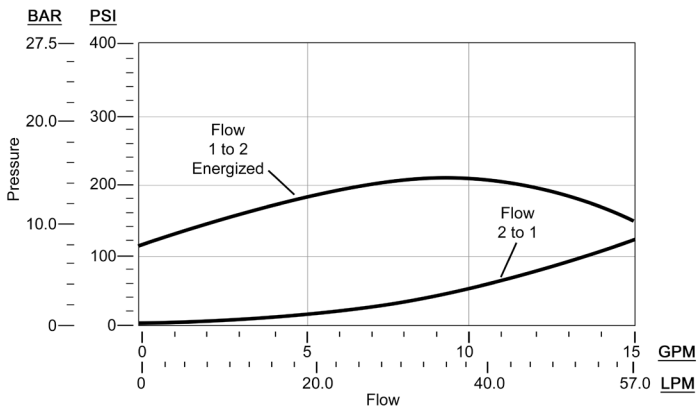

(Flow 1 to 2 with coil energized)

**DFBE-\*H\* & DFBG-\*H\***  
(Normally open)

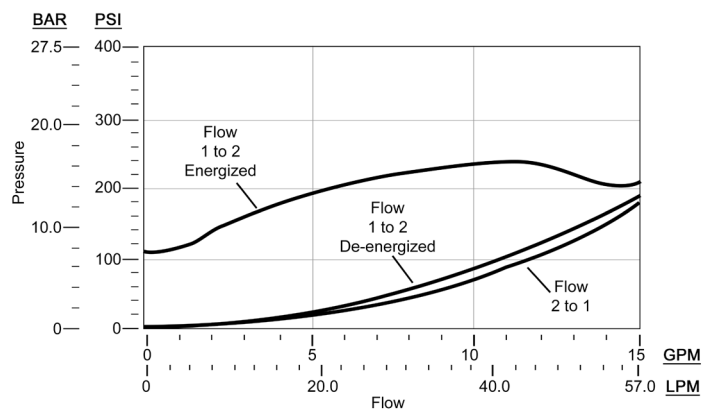

## DFB\* FAMILY WITH 740 SERIES LOW- & HIGH-POWER COILS

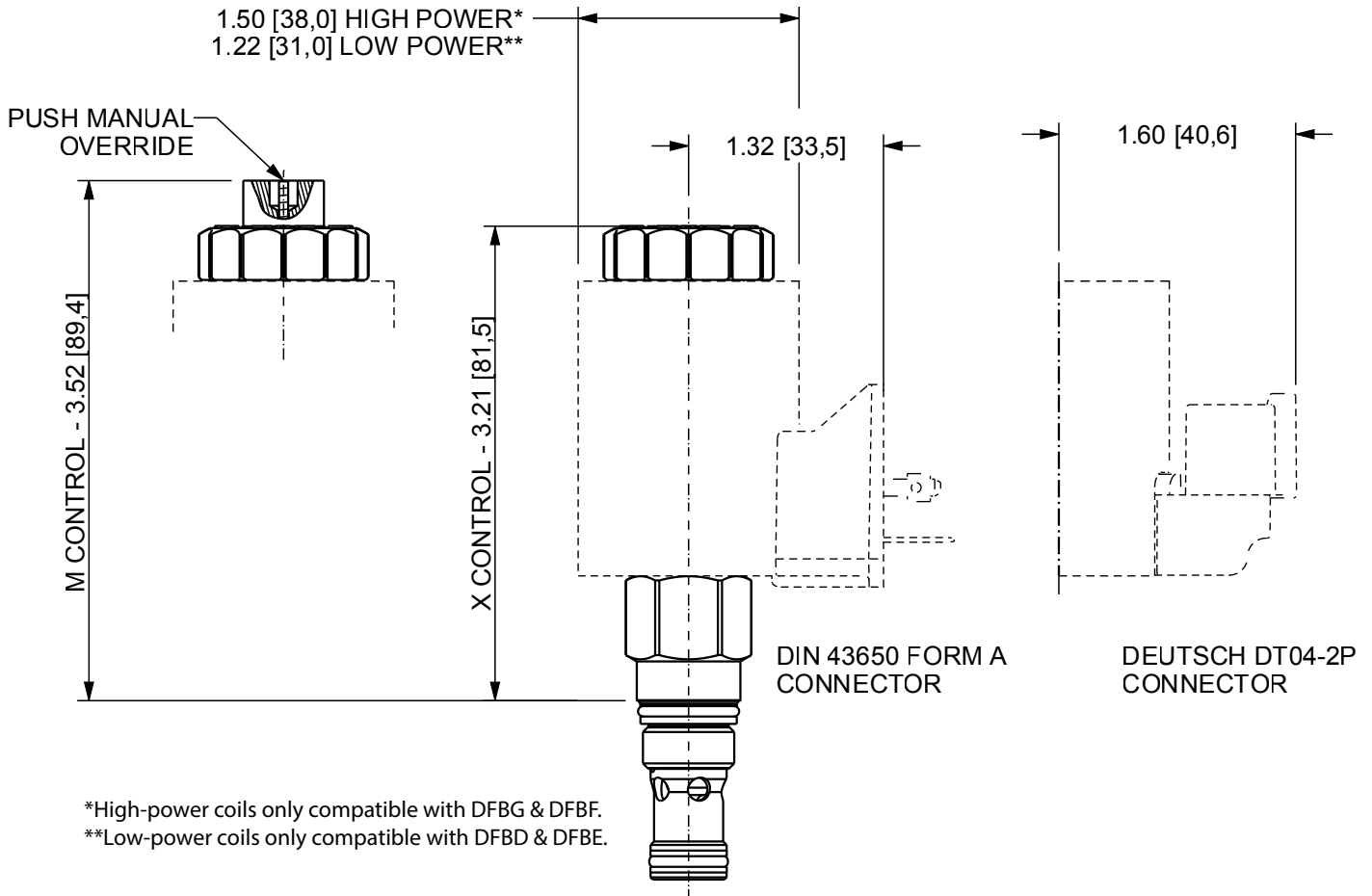

## 747 SERIES HAZARDOUS LOCATION COILS

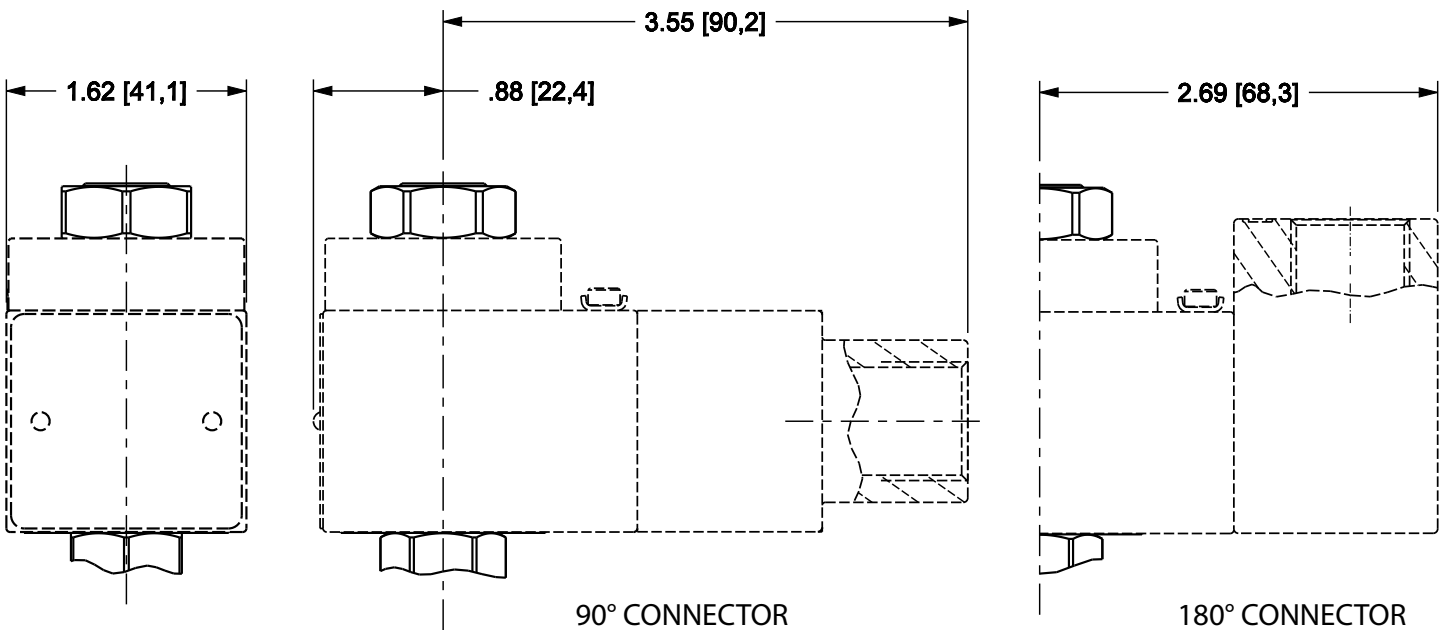

NOTE: Please verify cartridge clearance requirements when choosing a Sun manifold. Different valve controls and coils require different clearances. An additional minimum 2.0 in. (50,8 mm) beyond the valve extension is needed for coil installation and removal.

T-162A CAVITY DIMENSIONAL DRAWING

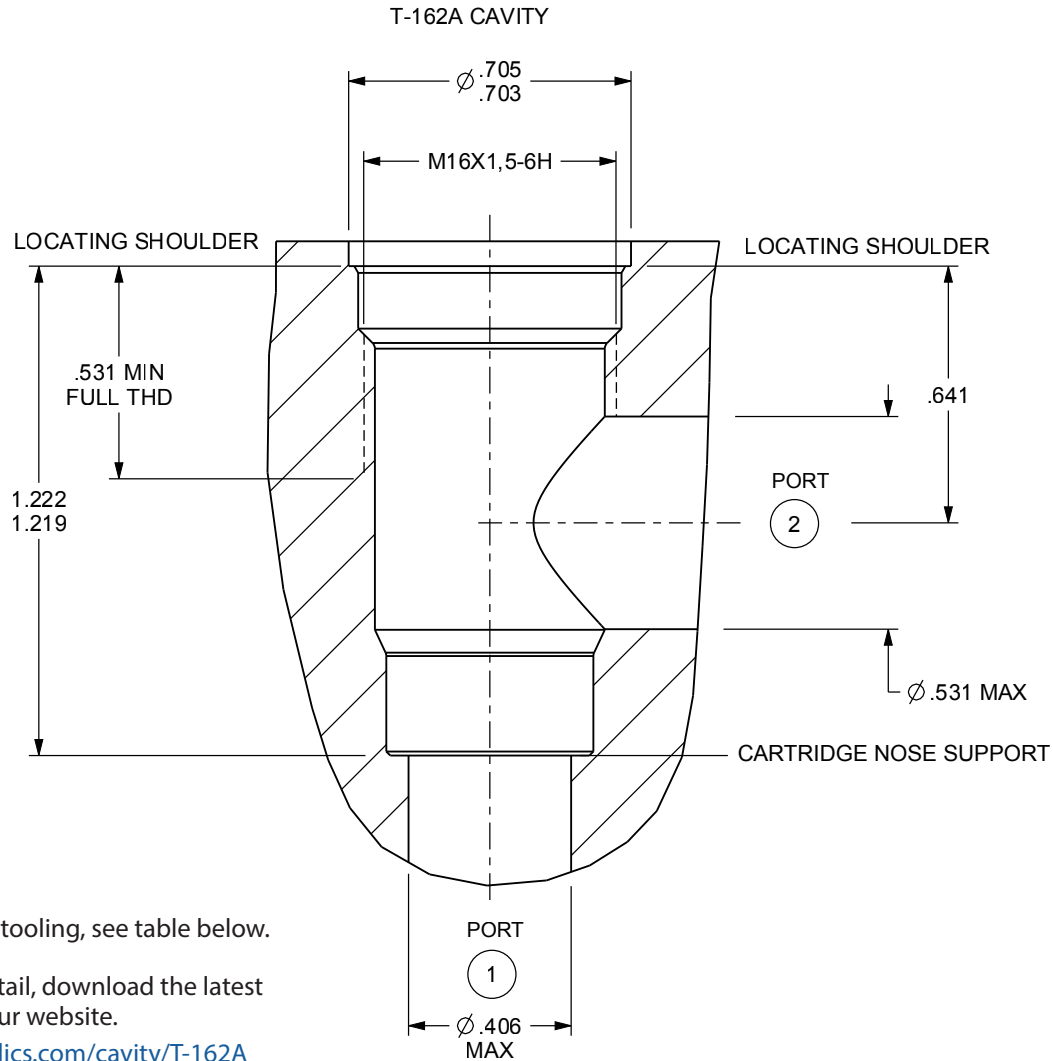

NOTE: For cavity tooling, see table below.

For full cavity detail, download the latest drawings from our website.

[www.sunhydraulics.com/cavity/T-162A](http://www.sunhydraulics.com/cavity/T-162A)

T-162A CAVITY TOOLING

DESCRIPTION	HIGH-SPEED STEEL	TITANIUM COATED
M16 X 1.5-6H tap, straight shank	998991	998991101
Series 0 deep hex socket	998100005	
T-162A cavity form drill, morse taper	994162001	994162101
T-162A cavity form drill, straight shank		994162102
T-162A cavity form reamer, morse taper	995162001	995162101
T-162A cavity form reamer, straight shank		995162102

# ADDITIONAL INFORMATION

## ACCESSORIES

DESCRIPTION	PART NUMBER
Wire harness, 2-pin Deutsch-to-Metri-Pack Conversion	991-717
Wire harness, 2-pin Deutsch-to-Amp Jr Timer Conversion	991-718
Wire harness, 2-pin Deutsch-to-Twin-Lead Conversion	991-719

## STANDARD LINE-MOUNT & SANDWICH MANIFOLDS

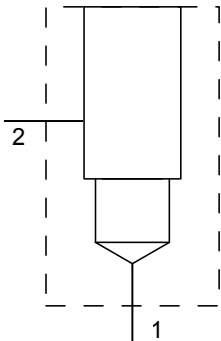

Compatible with the DFB\* family of FLeX valves, Sun Hydraulics offers 31 standard line-mount manifolds in 90°, in-line, through port 1 with gauge port, cross port and direct mount (banjo bolt) versions for the T-162A cavity. Standard products include one- and two-cavity versions in a wide range of port sizes. The popular AAJ model line-mount 90° manifold (shown at left) has a single cavity and SAE 8 ports.

In sandwich manifolds, we offer 26 standard bodies based on the T-162A cavity that include a range of interfaces in one- or two-cavity versions.

To search our complete line of standard manifolds, go to [www.SunHydraulics.com/models/manifolds](http://www.SunHydraulics.com/models/manifolds).



Sun Hydraulics Headquarters  
Sarasota, Florida USA  
(1) 941 362 1200  
[suninfo@sunhydraulics.com](mailto:suninfo@sunhydraulics.com)

Sun Hydraulics Limited  
Coventry England  
+44 2476 217 400  
[sales@sunuk.com](mailto:sales@sunuk.com)

Sun Hydraulik GmbH  
Erkelenz Germany  
+49 2431 80910  
[sales@sunhydraulik.de](mailto:sales@sunhydraulik.de)

Sun Hydraulics Corp. (India)  
Bangalore India  
+91 8028 456325  
[sunindiainfo@sunhydraulics.com](mailto:sunindiainfo@sunhydraulics.com)

Sun Hydraulics Korea Corp.  
Incheon Korea  
+82 3281 31350  
[sales@sunhydraulics.co.kr](mailto:sales@sunhydraulics.co.kr)

Sun Hydraulics China Co. Ltd.  
Shanghai P.R. China  
+86 2151 162862  
[sunchinainfo@sunhydraulics.com](mailto:sunchinainfo@sunhydraulics.com)

Sun Hydraulics Corp. (S.America)  
Rosario, Argentina  
+54 9 341 584 3075  
[ventas@sunhydraulics.com](mailto:ventas@sunhydraulics.com)

October 2017